



ROBOTICS  
PROVISION  
JOIN THE ROBOLUTION!

# PUDU CC1

Clean & Clever, Four-in-1

Global Leading Robotics Company

# Content

## About PUDU CC1

---

**01**

**Product Overview**

**02**

**Product Advantages**

**03**

**Product Values**

**04**

**About Pudu**

# Product Overview



# Product Overview



<b>Machine Dimension</b>	663*568*682mm
<b>Machine weight</b>	69kg
<b>Sweeping Width</b>	500mm
<b>Scrubbing Width</b>	400mm
<b>Water Tank Capacity</b>	Clean Water Tank 15L Waste Water Tank 15L
<b>Charging Time</b>	< 3h
<b>Run-time</b>	Max 8h
<b>Cleaning Efficiency</b>	700-1000m <sup>2</sup> /h
<b>Cleaning Operating Noise</b>	< 70dB
<b>Cruise Speed</b>	Max 1.2m/s
<b>Local Interaction</b>	10.1-inch touch screen
<b>Positioning Method</b>	Visual + Laser Positioning

# Content

## About PUDU CC1

---

01

Product Overview

02

Product Advantages

03

Product Values

04

About Pudu

# Product Advantages

## Four-in-one Versatile Cleaning

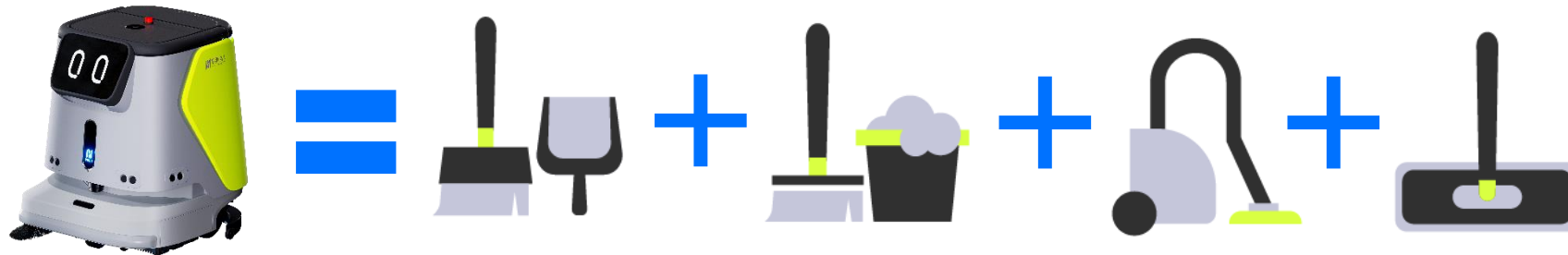

- **Sweeping, Scrubbing, Vacuuming and Dust Mopping** multi-function in one. All cleaning needs can be easily met by one machine.
- **Two main cleaning modes:**
  1. Sweeping + Vacuuming + Mopping
  2. Scrubbing
- **Modular Component Design:** Removing the accessory is no longer a tedious task, but a fast and efficient one. **Accessories (such as side brush, roller brush, squeegee, and mopping sweeper)** can be loaded and unloaded within **1 minute**.

# Product Advantages

## Suit Various Floor Types

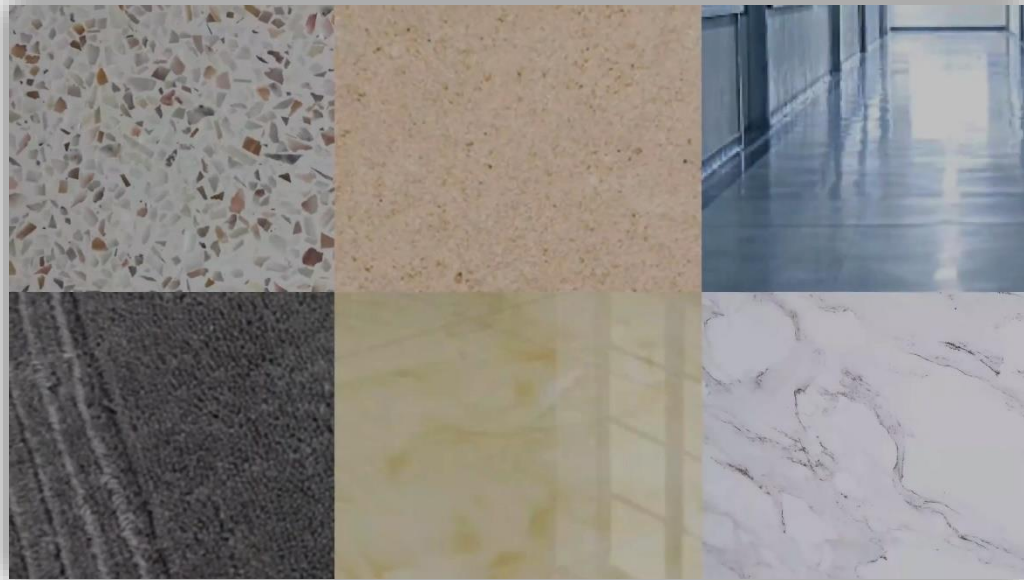

- Suitable for indoor floors with **different materials and hardness**:
- **Hard floor**: Nature Stone, Terrazzo, marble, floor tile, epoxy resin, sandstone, artificial stone flooring, etc.
- **Soft floor**: Low-pile carpet

# Product Advantages

## Fit Corners Perfectly



- **Ultimate edge cleaning (< 6cm edge to edge)** in certain scenes with side brushes. It performs edge sweeping well with no trash left behind.



# Product Advantages

## Automatic Recharging

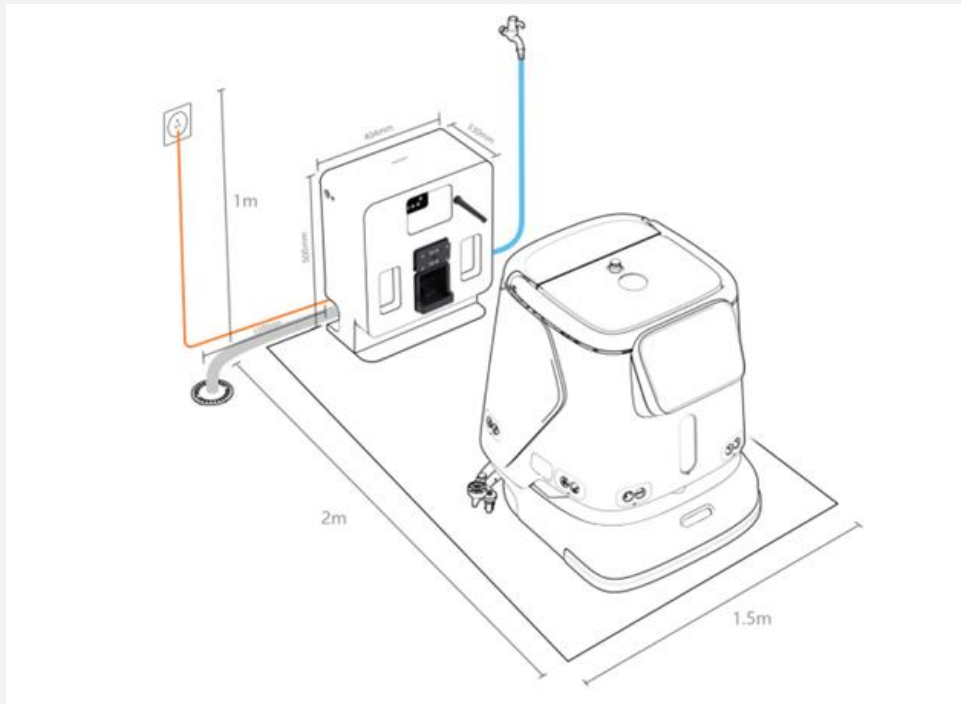

- **The robot will automatically return to the workstation\*** when the power is low.

\*The workstation needs to be purchased additionally

# Product Advantages

## Automatic Water Addition & Drainage



- **Large Capacity: 15L clean water tank and 15L waste water tank** with an exclusive workstation
- **Automatically fill and drain the water** at the workstation\*
- No manual intervention, worry-free and labor-saving

# Product Advantages

## Digital Cleaning

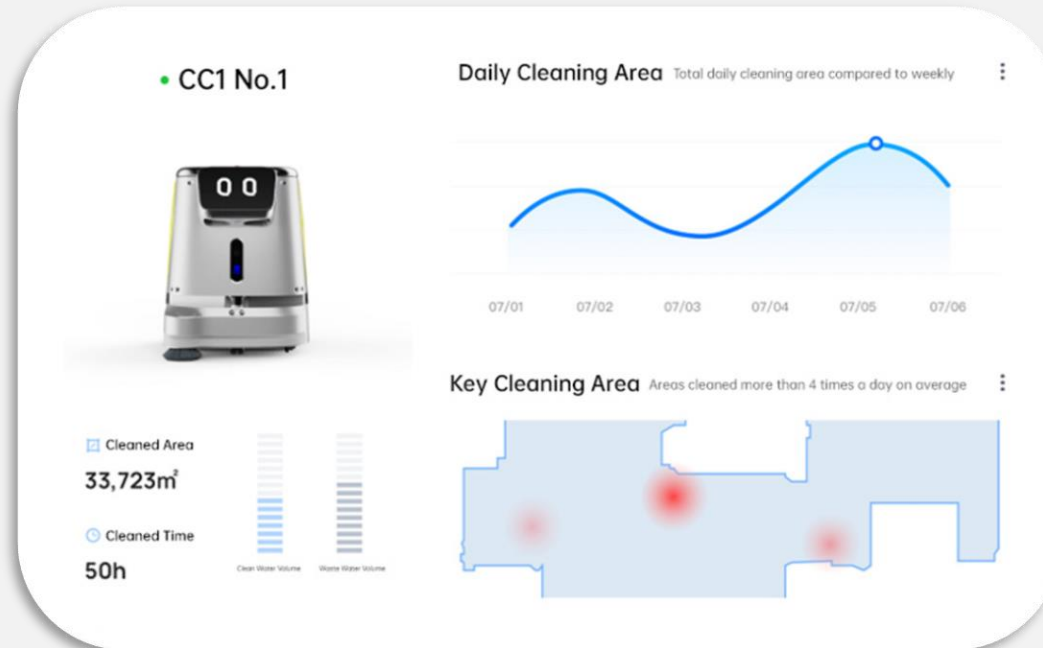
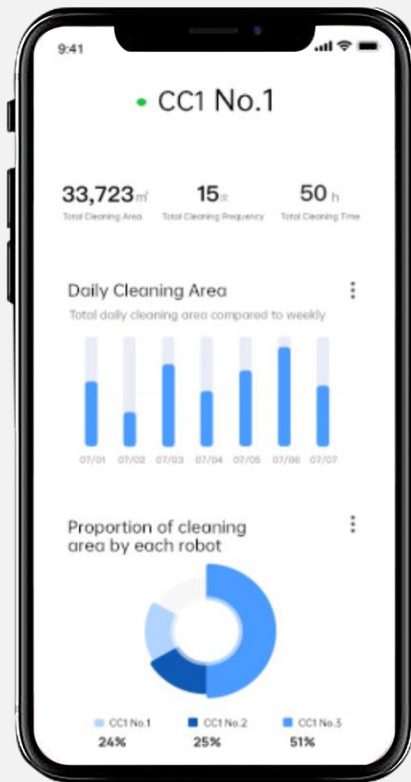

- **Remote operation** via APP, work status can be checked at any time.
- Get **real-time notifications** for cleaning performance, such as cleaning time and cleaning area.
- **Digitization and visualization** of cleaning effects: collect and summarize the **working status** of each unit, and automatically generate cleaning reports.

# Product Advantages

## Automatic Localization & Navigation

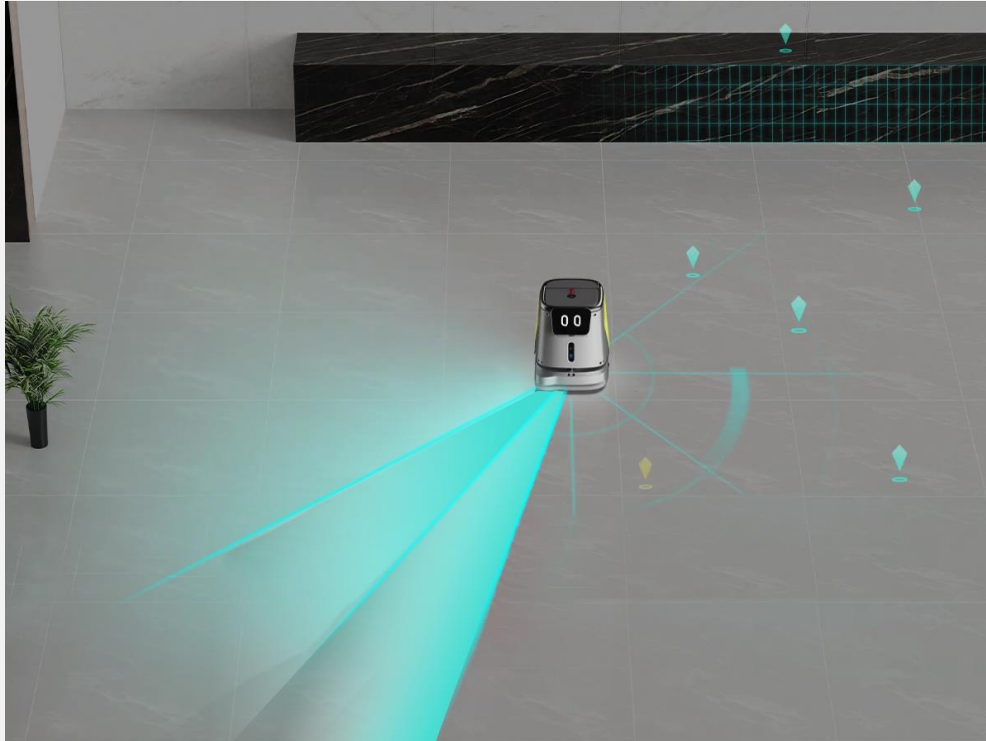

- Based on PUDU SLAM positioning system, CC1 supports both **Visual SLAM and Laser SLAM positioning and navigation** solutions to perform tasks more efficiently in complex scenarios.
- Equipped with **Multi-fusion sensors**, it can stop at any angle and move away as soon as it encounters obstacles.

# Product Advantages

## Breakpoint Resume Cleaning

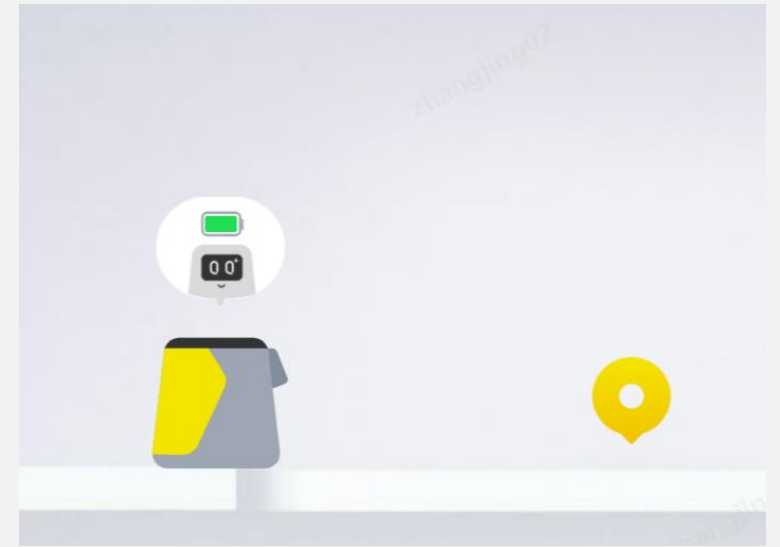
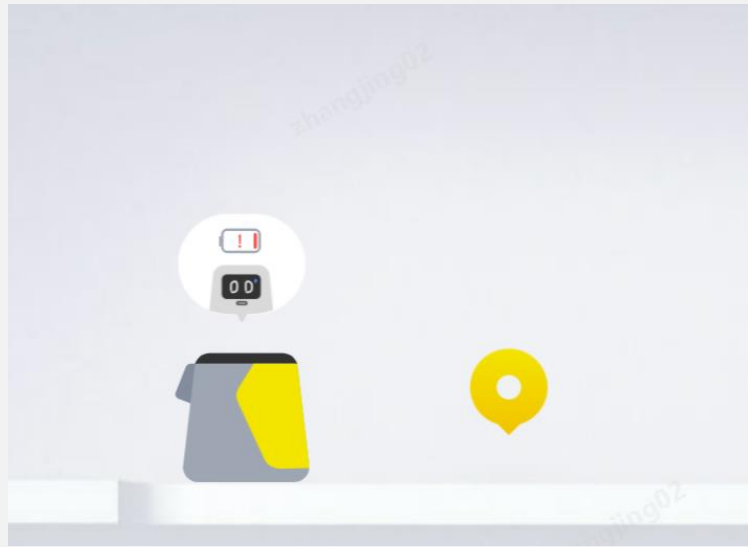

- When the power is low and the cleaning task is not completed, the robot can **remember the cleaning progress** and **resume the previous unfinished task** after being fully recharged.

# Product Advantages

## Multi-machine Intelligent Scheduling

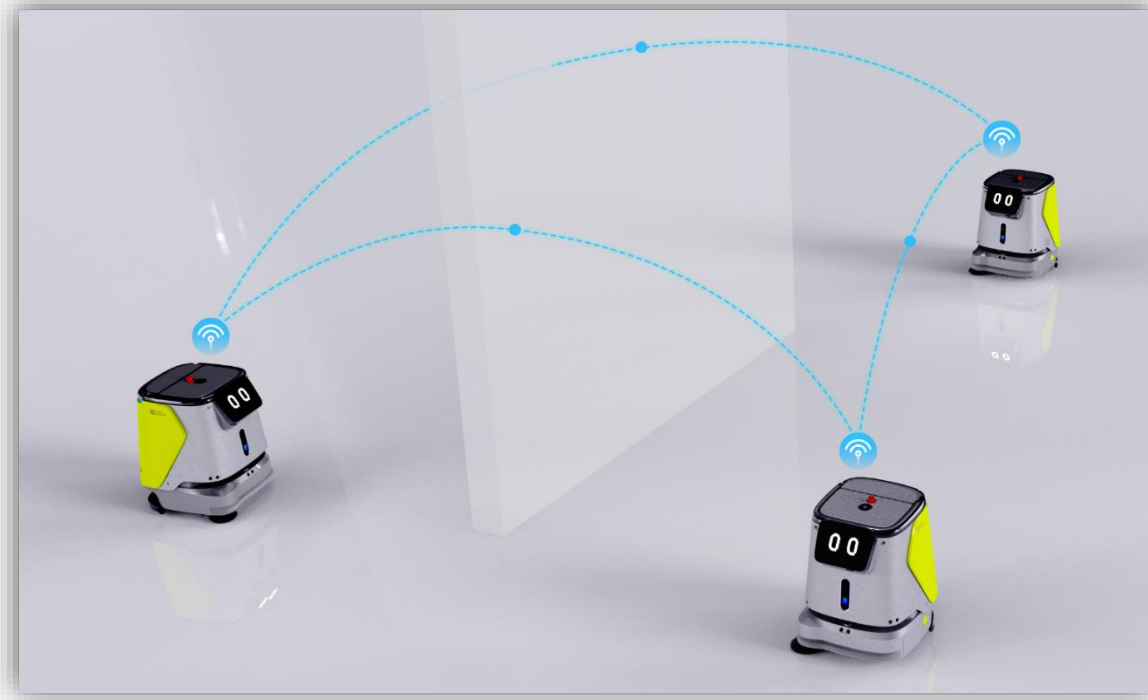

- Based on PUDU Scheduler technology, it supports **multi-machine intelligent scheduling** and realizes multi-machine collaborative operation, automatic replacement, multi-machine to multi-workstation and other functions, and realizes the systematic operation of robots in office buildings/residential buildings.

# Content

## About PUDU CC1

---

01

Product Overview

02

Product Advantages

03

Product Values

04

About Pudu

# Product Values

## PUDU CC1

### Intelligent Commercial Cleaning Robot

- Enhances cleaning efficiency and public image
- Improve cost effectiveness and cleaning quality
- Reallocates custodial efforts to higher-value tasks
- Provides detailed reports for a measurable clean





# Product Values



- **Simplify your cleaning processes** and improve your workflow: pre-set program enables CC1 to start operating automatically and immediately
- Stable cleaning efficiency and **higher quality of cleaning**



- **Reduce risks of workforce challenges**, such as employee absenteeism and turnover
- **Redeploy labor**: Employees can focus on more complex responsibilities, ensuring more productivity.



- **Lower** recruitment, training and management **costs**: simple operation and user-friendly interface, set up and use in hours with minimal training



- With **measurable records and reports**, custodial inspections can be easily dealt with, and work status can be optimized.

# Usage Scenarios



**Office Building**



**Education**



**Retail**



**Food & Beverage**



**Public Transportation**



**Health Care**



**Manufacturing**

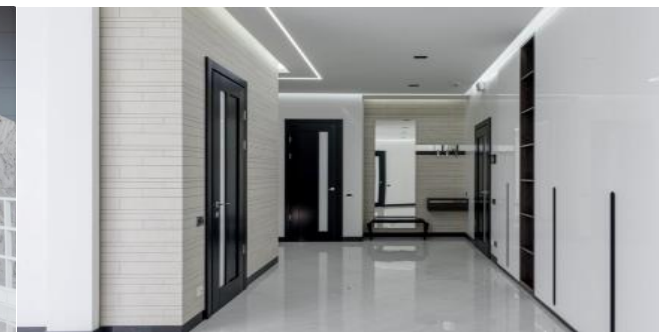

**Hospitality**

# Content

## About PUDU CC1

---

**01**

**Product Overview**

**02**

**Product Advantages**

**03**

**Product Values**

**04**

**About Pudu**

# Pudu Robotics



Shenzhen-based and founded in 2016, Pudu Robotics is a world-leading tech-focused enterprise dedicated to the design, R&D, production and sales of commercial service robots on a mission to use robots to improve the efficiency of human production and living.

Since its inception, Pudu Robotics has heavily invested in R&D, obtained multiple awards such as Red Dot and applied hundreds of core patents to lead the development of the robotics category and provide high technology products that would appeal to targeted markets. Pudu Robotics has been rapidly growing in recent years to become a “leader” in the global markets with coverage of over 60 countries worldwide. The robots are widely applied in restaurants, hospitals, schools, office buildings, government halls, subway stations, waiting rooms, etc.

# Sales Network

Pudu Robotics is exploring the global markets rapidly and currently with the coverage of over 60 countries and 600 cities worldwide. We are on the way to explore and deliver more to the future!



# Culture



THINKING IN THE LIGHT  
OF FIRST PRINCIPLES



BE INVENTIVE



BE ENTERPRISING &  
ACCOUNTABLE



BE OPEN-UP



MOVING FAST



BE CUSTOMER  
CENTRIC



EMBRACING  
CHANGES



PURSuing FOR  
THE ULTIMATE

A dark blue world map is centered in the background of the slide. The map shows the outlines of continents and countries in a lighter shade of blue.

# After Sales Service

---

- **Offline Service: 1 Year Free Warranty | 7 × 24 Hours Service | Local Service & Support**

Pudu Robotics has a thorough after-sales support system and humanized after-sales policy as well, whenever it is needed, we are going all out to offer service and reach your satisfaction.



ROBOTICS  
PROVISION  

---

JOIN THE ROBOLUTION!

T H A N K S

